





# VALVE HEAD I40 TYPE N



ART. NO. 310044

## GENERAL

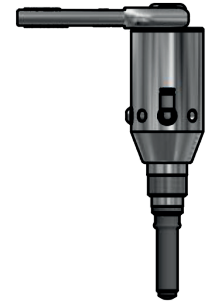
-  The KEOFIT CLASSIC “INGOLD” Sampling Valve owes its hygienic design and one-piece construction to the original KEOFIT valve. Unique serial no. for each valve\*.
-  The sampling valve can be used for any process sampling for microbiological, chemical and/or physical analysis.
-  **Cleaning/sterilizing:** Between batches: Valve in open position: Cleanable by means of CIP using the detergent solution suitable for the actual process media. Between samples: Valve in its normal closed position: cleanable by CIP as “Between batches” or the valve may be sterilized by means of steam SIP or chemical SIP using a procedure appropriate to the actual circumstances. For further advice, please contact KEOFIT. Autoclavabile.
-  Designed for sampling of liquids with a viscosity of up to approx. 1.000 cP containing no particles larger than Ø2 mm. Sampling of more viscous liquids is possible, only will it take longer (depending on process pressure).



## FEATURES

-  Installation: Threaded connection (I40)
-  Membrane: Silicone (#310051)
-  Operation: Pneumatically operated / Lever handle (#600170)  
Spring closed - when not pressurized

## CERTIFICATION\*

- Valve head: EU EC 1935/2004 · EU EC 2023/2006 · DK No 681 25/05/20 · ATEX 2014/34/EU · PED 2014/68/EU · FDA CFR 21 §177.1550 · USP Class VI · Keofitt DoC.
- Membrane: EU EC 1935/2004 · EU EC 2023/2006 · DK No 681 25/05/20 · FDA CFR 21 §177.2600 · USP Class VI · REACH · RoHS · ADI Free · Keofitt DoC.

## TECHNICAL DATA

### Material (process contact)

Membrane: Silicone, grey (#310051)

### Material (without process contact)

Steel parts: AISI 303 (1.4305) / AISI 316L (1.4404)  
Lever handle: AISI 316L (1.4404)

### Pressure & Temperature

Pressure: 0 -10 bar / 0 - 145 psi  
Temperature: 1 - 130°C / 34 - 266°F  
Air supply: 4 - 7 bar / 58 - 101 psi

### Net weight

Kg/lbs: 0.899 kg / 1.98 lbs

## SPARE PARTS

# 773144 Parts for I40 valve head #310044

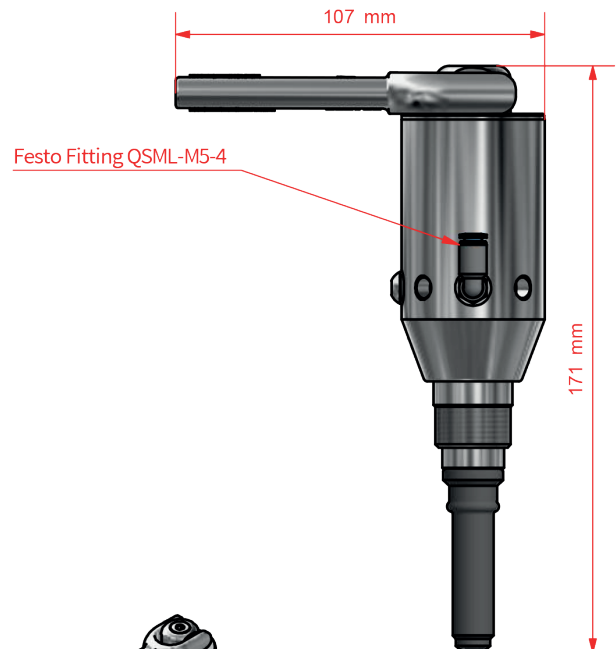

\*For further information and downloads please visit [www.keofitt.dk](http://www.keofitt.dk)