





# VALVE HEAD I40 TYPE Q PTFE

ART. NO. 315543

## GENERAL

-  The KEOFITT CLASSIC "INGOLD" Sampling Valve owes its hygienic design and one-piece construction to the original KEOFITT valve. Unique serial no. for each valve\*.
-  The sampling valve can be used for any process sampling for microbiological, chemical and/or physical analysis.
-  **Cleaning/sterilizing:** Between batches: Valve in open position: Cleanable by means of CIP using the detergent solution suitable for the actual process media. Between samples: Valve in its normal closed position: cleanable by CIP as "Between batches" or the valve may be sterilized by means of steam SIP or chemical SIP using a procedure appropriate to the actual circumstances. For further advice, please contact Keofitt. Autoclavable.
-  Designed for sampling of liquids with a viscosity of up to approx. 1.000 cP containing no particles larger than Ø2 mm. Sampling of more viscous liquids is possible, only will it take longer (depending on process pressure).

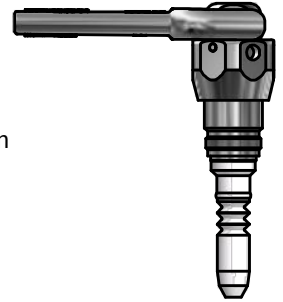

## FEATURES

-  Installation: Threaded connection (I40)
-  Operation: Lever handle (#600170)
-  Membrane: PTFE (#310055)

## CERTIFICATION\*

· EU EC 1935/2004 · EU EC 2023/2006 · EU EC 10/2011 · DK No 681 25/05/20 · ATEX 2014/34/EU · PED 2014/68/EU · FDA CFR 21 §177.1550 · USP Class VI · Keofitt DoC

## TECHNICAL DATA

### Material (process contact)

- Membrane PTFE, WHITE (#310055)

### Material (without process contact)

- Steel parts AISI 303 (1.4305) / AISI 316L (1.4404)
- Lever handle AISI 316L (1.4404)

### Membrane

- Article PTFE, WHITE (#310055)
- Certification\* · EU EC 1935/2004 · EU EC 2023/2006 · EU EC 10/2011 · DK No 681 25/05/20 · FDA CFR 21 §177.1550 · USP Class VI · ADI Free · Keofitt DoC

### Pressure & Temperature

- Pressure 0 - 10 bar / 0 - 145 psi
- Temperature 1 - 150°C / 34 - 302°F
- Air supply -

### Net Weight

- kg/lbs 0.356 kg/0.785 lbs

### Spareparts

- 773141PTFE PARTS FOR I40 HEAD 315541/43

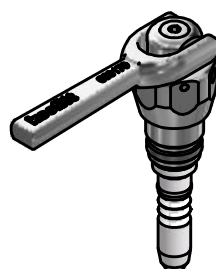
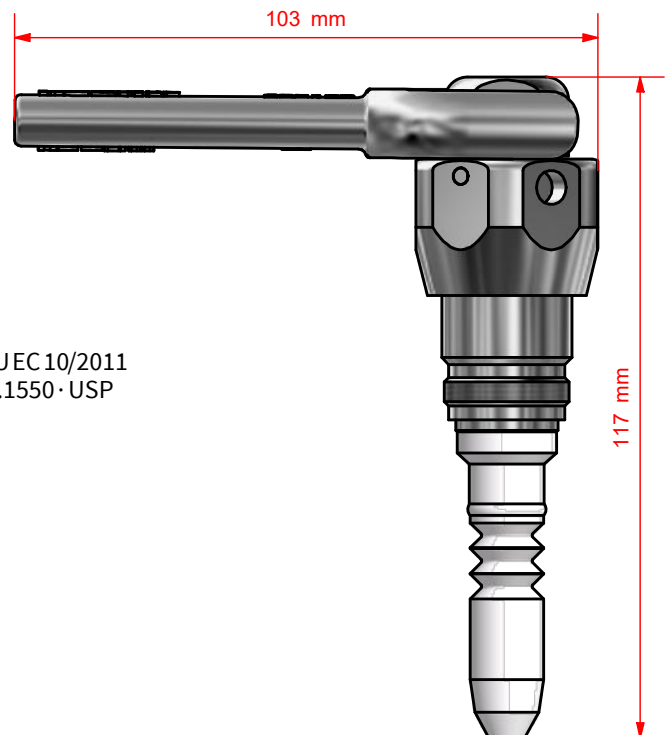

\*For further information and download please visit [www.keofitt.dk](http://www.keofitt.dk)