





VALVE HEAD M4 TYPE Q



ART. NO. 400043

GENERAL

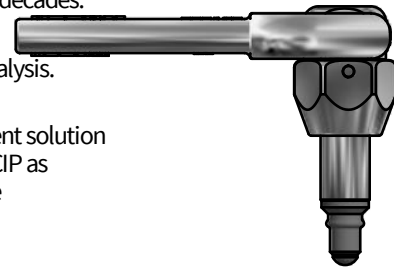
-  The KEOFITT CLASSIC M4 Sampling Valve is the smallest KEOFITT sampling valve. Used in all industries for decades. More than 120 standard valve configurations. Unique serial no. for each valve*.
-  The sampling valve can be used for any process sampling for microbiological, chemical and/or physical analysis.
-  **Cleaning/sterilizing:** Between batches: Valve in open position: Cleanable by means of CIP using the detergent solution suitable for the actual process media. Between samples: Valve in its normal closed position: cleanable by CIP as "Between batches" or the valve may be sterilized by means of steam SIP or chemical SIP using a procedure appropriate to the actual circumstances. For further advice, please contact Keofitt. Autoclavable.
-  Designed for sampling of liquids with a viscosity of up to approx. 100 cP containing no particles larger than Ø1.5 mm. Sampling of more viscous liquids is possible, only will it take longer (depending on process pressure).



FEATURES

-  Installation: Threaded socket connection M16x1
-  Operation: Lever handle (#600170)
-  Membrane: Silicone (#400051)

CERTIFICATION*

· EU EC 1935/2004 · EU EC 2023/2006 · DK No 681 25/05/20 · 3-A Certificate · ATEX 2014/34/EU · PED 2014/68/EU · FDA CFR 21 §177.2600 · USP Class VI · Keofitt DoC

TECHNICAL DATA

Material (process contact)

- Membrane SILICONE, GREY (#400051)

Material (without process contact)

- Steel parts AISI 303 (1.4305) / AISI 316L (1.4404)
- Lever handle AISI 316L (1.4404)

Membrane

- Article SILICONE, GREY (#400051)
- Certification* · EU EC 1935/2004 · EU EC 2023/2006 · DK No 681 25/05/20 · FDA CFR 21 §177.2600 · USP Class VI · REACH · RoHS · ADI Free · Keofitt DoC

Pressure & Temperature

- Pressure 0 - 10 bar / 0 - 145 psi
- Temperature 1 - 130°C / 34 - 266°F
- Air supply -

Net Weight

- kg/lbs 0.201 kg/0.443 lbs

Spareparts

- 774041 PARTS FOR M4 HEAD 400041/42/43/47

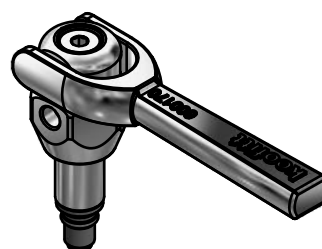
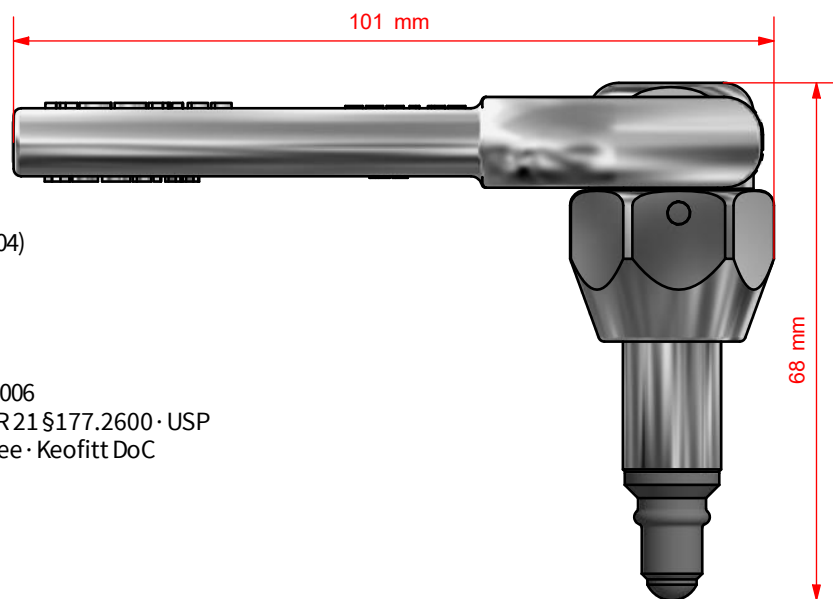

*For further information and download please visit www.keofitt.dk