





# VALVE HEAD 4KAI TYPE H EPDM



ART. NO. 440041E

## GENERAL

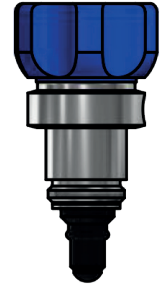
-  The KEOFITT 4KAI Sampling Valve is our low cost sterilizable sampling valve for less demanding applications. Replaces non-hygienic sampling cocks. More than 20 different configurations available.
-  The sampling valve can be used for any process sampling for chemical and/or physical analysis.
-  Cleaning/sterilizing: Between batches: Valve in open position: Cleanable by means of CIP using the detergent solution suitable for the actual process media. Between samples: Valve in its normal closed position: cleanable by CIP as “Between batches” or the valve may be sterilized by means of steam SIP or chemical SIP using a procedure appropriate to the actual circumstances. For further advice, please contact KEOFITT. Not recommended for autoclave due to plastic parts.
-  Designed for sampling of liquids with a viscosity of up to approx. 100 cP containing no particles larger than Ø1.5 mm. Sampling of more viscous liquids is possible, only will it take longer (depending on process pressure).



## FEATURES

-  Installation: Threaded socket connection M18x1.5
-  Membrane: EPDM (#400052)
-  Operation: Turn knob - spring loaded (opens counter-clockwise)

## CERTIFICATION\*

- Valve head: EU EC 1935/2004 · EU EC 2023/2006 · DK No 681 25/05/2020 · 3-A Certificate · ATEX 2014/34/EU · PED 2014/68/EU · FDA CFR 21 §177.2600 · USP Class VI · KEOFITT DoC.
- Membrane: EU EC 1935/2004 · EU EC 2023/2006 · DK No 681 25/05/2020 · FDA CFR 21 §177.2600 · USP Class VI · REACH · RoHS · ADI Free · KEOFITT DoC.

## TECHNICAL DATA

### Material (process contact)

Membrane: EPDM, black (#400052)

### Material (without process contact)

Steel parts: AISI 304 (1.4307)

Knob: PA6 (blue) / PTFE

### Pressure & Temperature

Pressure: 0 - 6 bar / 0 - 87 psi

Temperature: 1 - 130°C / 34 - 266°F

Air supply: -

### Net weight

Kg/lbs: 0.134 kg / 0.296 lbs

## SPARE PARTS

#774441EPDM Parts for 4KAI/BASIX Head H EPDM

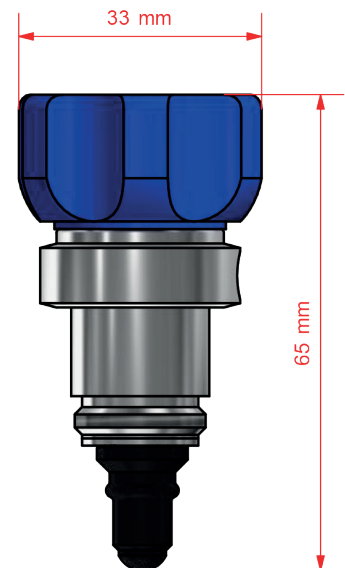

\*For further information and downloads please visit [www.keofitt.dk](http://www.keofitt.dk)