





BASIX VALVE TYPE T/H



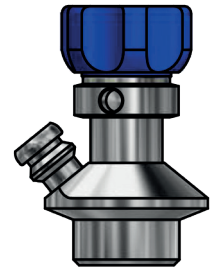

ART. NO. 450141

GENERAL

-  The KEOFITT BASIX Sampling Valve is our CIP-able sampling valve for less demanding applications. Replaces non-hygienic sampling cocks. More than 20 different configurations available
-  The sampling valve can be used for any process sampling for chemical and/or physical analysis.
-  Cleaning: Valve in open position: Cleanable by means of CIP using the detergent solution suitable for the actual process media. For further advice, please contact KEOFITT. Not recommended for autoclave due to plastic parts.
-  Designed for sampling of liquids with a viscosity of up to approx. 100 cP containing no particles larger than Ø1.5 mm. Sampling of more viscous liquids is possible, only will it take longer (depending on process pressure).



FEATURES

-  Installation: Tank welding
-  Membrane: Silicone (#400051)
-  Head assembly: Hand tight using a tommy bar or maximum 15 Nm. Tommy bar included (#900118).
-  Outlet: Hose piece
-  Operation: Turn knob - spring loaded (opens counterclockwise)

CERTIFICATION*

- Valve: EU EC 1935/2004 · EU EC 2023/2006 · DK No 681 25/05/2020 · 3-A Certificate · 3.1 certificate ATEX 2014/34/EU · PED 2014/68/EU · FDA CFR 21 §177.2600 · USP Class VI · KEOFITT DoC.
- Membrane: EU EC 1935/2004 · EU EC 2023/2006 · DK No 681 25/05/2020 · FDA CFR 21 §177.2600 · USP Class VI · REACH · RoHS · ADI Free · KEOFITT DoC.

TECHNICAL DATA

Material (process contact)

- Steel parts: AISI 316L (1.4404)
Membrane: Silicone, grey (#400051)

Material (without process contact)

- Steel parts: AISI 304 (1.4307)
Knob: PA6 (blue) / PTFE

Surface Treatment

- Outside: Ra ≤ 1.2 µm
Inside (wetted surface): Ra ≤ 0.8 µm
Process connection: Ra ≤ 0.8 µm

Pressure & Temperature

- Pressure: 0 - 6 bar / 0 - 87 psi
Temperature: 1 - 130°C / 34 - 266°F
Air supply: -

Net weight

- Kg/lbs: 0.298 kg / 0.656 lbs

SPARE PARTS

- #774441 Parts for 4KA1/Basix/ Head H

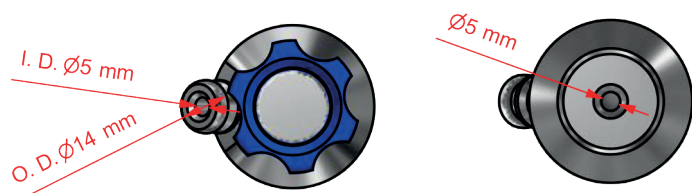
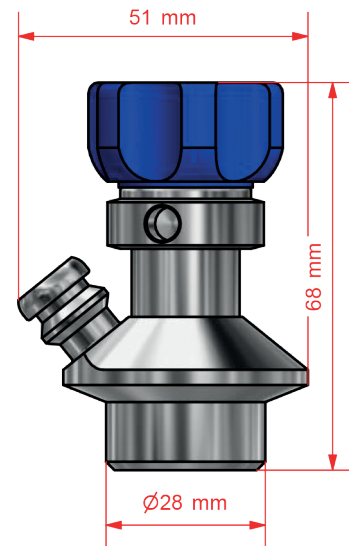

*For further information and downloads please visit www.keofitt.dk