





BASIX VALVE TYPE T/N PTFE



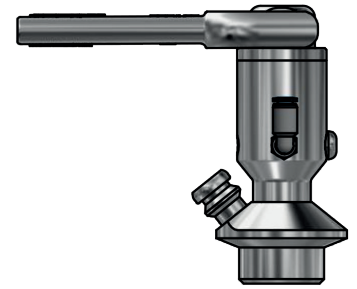

ART. NO. 450144PTFE

GENERAL

-  The KEOFITT BASIX Sampling Valve is our CIP-able sampling valve for less demanding applications. Replaces non-hygienic sampling cocks. More than 20 different configurations available
-  The sampling valve can be used for any process sampling for microbiological, chemical and/or physical analysis.
-  Cleaning: Valve in open position: Cleanable by means of CIP using the detergent solution suitable for the actual process media. For further advice, please contact KEOFITT. Autoclavable.
-  Designed for sampling of liquids with a viscosity of up to approx. 100 cP containing no particles larger than Ø1.5 mm. Sampling of more viscous liquids is possible, only will it take longer (depending on process pressure).



FEATURES

-  Installation: Tank welding
-  Membrane: PTFE, white (#400055)
-  Head assembly: Hand tight using a tommy bar or maximum 15 Nm. Tommy bar included (#900118).
-  Outlet: Hose piece
-  Operation: Pneumatically operated/
Lever handle (#600170)
Spring closed - when not pressurized.

CERTIFICATION*

- Valve: EU EC 1935/2004 · EU EC 2023/2006 · EU EC 10/2011 · DK No 681 25/05/20 · 3-A Certificate · 3.1 Material Certificate · ATEX 2014/34/EU · PED 2014/68/EU · FDA CFR 21 §177.1550 · USP Class VI · KEOFITT DoC.
- Membrane: EU EC 1935/2004 · EU EC 2023/2006 · EU EC 10/2011 · DK No 681 25/05/20 · FDA CFR 21 §177.1550 · USP Class VI · ADI Free · KEOFITT DoC.

TECHNICAL DATA

Material (process contact)

- Steel parts: AISI 316L (1.4404)
Membrane: PTFE, white (#400055)

Material (without process contact)

- Steel parts: AISI 304 (1.4307)
Lever handle: AISI 316L (1.4404)

Surface Treatment

- Outside: Ra ≤ 1.2 µm
Inside (wetted surface): Ra ≤ 0.8 µm
Process connection: Ra ≤ 0.8 µm

Pressure & Temperature

- Pressure: 0 - 6 bar / 0 - 87 psi
Temperature: 1 - 150°C / 34 - 302°F
Air supply: 5 - 7 bar / 73 - 102 psi

Net weight

- Kg/lbs: 0.541 kg / 1.193 lbs

SPARE PARTS

- #774444PTFE Parts for 4KAI/Basix valve head N PTFE

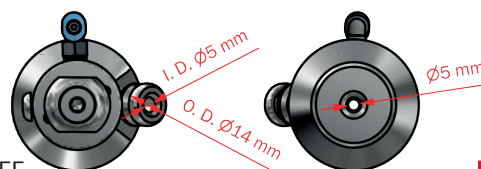
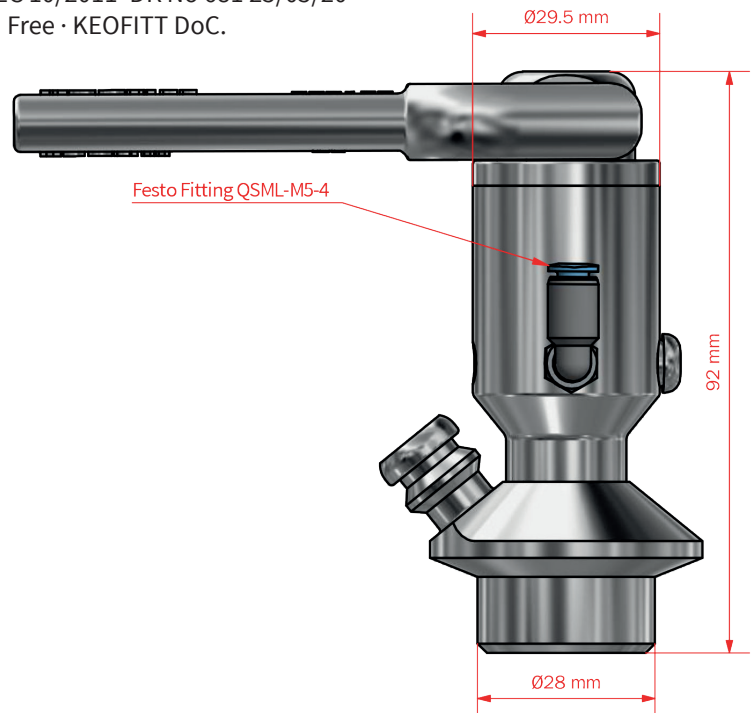

*For further information and downloads please visit www.keofitt.dk