





# BASIX VALVE TYPE MINI TRI-CLAMP/H



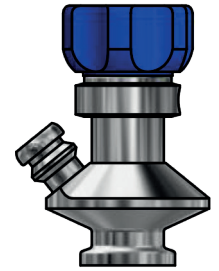

ART. NO. 452141

## GENERAL

-  The KEOFITT BASIX Sampling Valve is our CIP-able sampling valve for less demanding applications. Replaces non-hygienic sampling cocks. More than 20 different configurations available
-  The sampling valve can be used for any process sampling for chemical and/or physical analysis.
-  Cleaning: Valve in open position: Cleanable by means of CIP using the detergent solution suitable for the actual process media. For further advice, please contact KEOFITT. Not recommended for autoclave due to plastic parts.
-  Designed for sampling of liquids with a viscosity of up to approx. 100 cP containing no particles larger than Ø1.5 mm. Sampling of more viscous liquids is possible, only will it take longer (depending on process pressure).



## FEATURES

-  Installation: Mini Tri-Clamp DIN 32676:2009-05 Table 4 Row C
-  Membrane: Silicone (#400051)
-  Head assembly: Hand tight using a tommy bar or maximum 15 Nm. Tommy bar included (#900118).
-  Outlet: Hose piece
-  Operation: Turn knob - spring loaded (opens counterclockwise)

## CERTIFICATION\*

- Valve: EU EC 1935/2004 · EU EC 2023/2006 · DK No 681 25/05/2020 · 3-A Certificate · 3.1 Material Certificate · ATEX 2014/34/EU · PED 2014/68/EU · FDA CFR 21 §177.2600 · USP Class VI · KEOFITT DoC.
- Membrane: EU EC 1935/2004 · EU EC 2023/2006 · DK No 681 25/05/2020 · FDA CFR 21 §177.2600 · USP Class VI · REACH · RoHS · ADI Free · KEOFITT DoC.

## TECHNICAL DATA

### Material (process contact)

- Steel parts: AISI 316L (1.4404)  
Membrane: Silicone, grey (#400051)

### Material (without process contact)

- Steel parts: AISI 304 (1.4307)  
Knob: PA6 (blue) / PTFE

### Surface Treatment

- Outside: Ra ≤ 1.2 µm  
Inside (wetted surface): Ra ≤ 0.8 µm  
Process connection: Ra ≤ 0.8 µm

### Pressure & Temperature

- Pressure: 0 - 6 bar / 0 - 87 psi  
Temperature: 1 - 130°C / 34 - 266°F  
Air supply: -

### Net weight

- Kg/lbs: 0.275 kg / 0.605 lbs

## SPARE PARTS

- #774441 Parts for 4KA1/Basix/ Head H

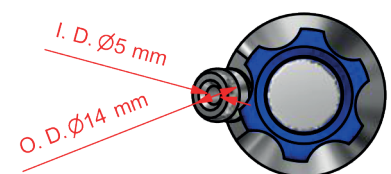
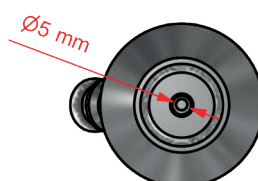
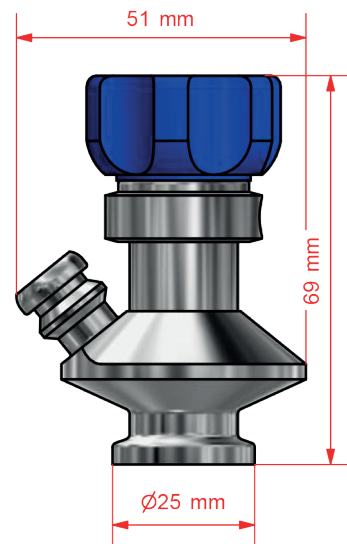

\*For further information and downloads please visit [www.keofitt.dk](http://www.keofitt.dk)