





VALVE BODY W9 S



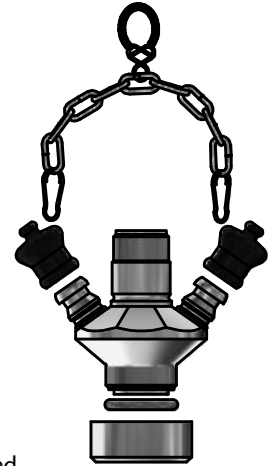

ART. NO. 850031

GENERAL

-  The KEOFITT CLASSIC W9 Sampling Valve is the original and leading sterilizable sampling valve in the world. Used in all industries for decades. More than 320 standard valve configurations. Unique serial no. for each valve*.
-  The sampling valve can be used for any process sampling for microbiological, chemical and/or physical analysis.
-  Cleaning/sterilizing: Between batches: Valve in open position: Cleanable by means of CIP using the detergent solution suitable for the actual process media. Between samples: Valve in its normal closed position: cleanable by CIP as "Between batches" or the valve may be sterilized by means of steam SIP or chemical SIP using a procedure appropriate to the actual circumstances. For further advice, please contact Keofitt.
-  Designed for sampling of liquids with a viscosity of up to approx. 1.000 cP containing no particles larger than Ø3 mm. Sampling of more viscous liquids is possible, only will it take longer (depending on process pressure).



FEATURES

-  Installation: Threaded socket connection M28x1.5
-  Operation: Depending on choice of valve head
-  Inlet / Outlet: Hose piece
-  Membrane: Depending on choice of valve head

CERTIFICATION*

· EU EC 1935/2004 · EU EC 2023/2006 · DK No 681 25/05/2020 · 3.1 Material Certificate · Ra Certificate · ATEX 2014/34/EU · PED 2014/68/EU · Keofitt DoC

TECHNICAL DATA

Material (process contact)

- Steel parts AISI 316L (1.4404)
- O-ring EPDM, BLACK (#900829)
- EU EC 1935/2004 · EU EC 2023/2006 · DK No 681 25/05/2020
- FDA CFR 21 §177.2600 · USP Class VI · ADI Free · Keofitt DoC

Material (without process contact)

- Steel parts AISI 316L (1.4404)
- Rubber cap EPDM (black)
- Stainless steel chain AISI 316L (1.4404)

Surface Treatment

- Outside Electropolished Ra ≤ 1.2 µm
- Inside (wetted surface) Electropolished Ra ≤ 0.5 µm
- Process connection Electropolished Ra ≤ 0.5 µm

Pressure & Temperature

- Pressure Depending on choice of valve head
- Temperature Depending on choice of valve head
- Air supply Depending on choice of valve head

Net Weight

- kg/lbs 0.395 kg/0.871 lbs

Spareparts

- 778531 PARTS FOR W9 BODY 850031

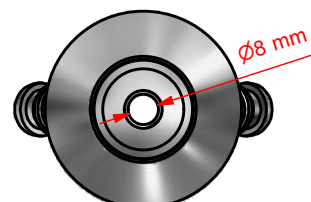
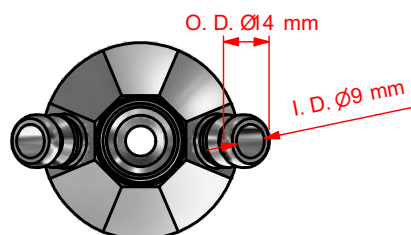
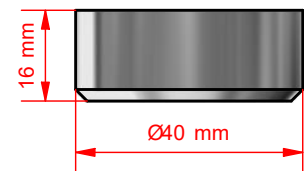
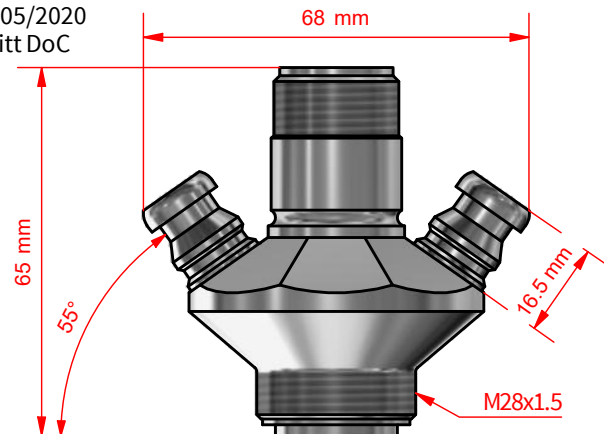

*For further information and download please visit www.keofitt.dk