





# VALVE BODY W9 UNION DN10 DIN 11851

ART. NO. 850040

## GENERAL

-  The KEOFITT CLASSIC W9 Sampling Valve is the original and leading sterilizable sampling valve in the world. Used in all industries for decades. More than 320 standard valve configurations. Unique serial no. for each valve\*.
-  The sampling valve can be used for any process sampling for microbiological, chemical and/or physical analysis.
-  Cleaning/sterilizing: Between batches: Valve in open position: Cleanable by means of CIP using the detergent solution suitable for the actual process media. Between samples: Valve in its normal closed position: cleanable by CIP as "Between batches" or the valve may be sterilized by means of steam SIP or chemical SIP using a procedure appropriate to the actual circumstances. For further advice, please contact Keofitt.
-  Designed for sampling of liquids with a viscosity of up to approx. 1.000 cP containing no particles larger than Ø3 mm. Sampling of more viscous liquids is possible, only will it take longer (depending on process pressure).



## FEATURES

-  Installation: Union DN10 DIN11851:2013-02
-  Operation: Depending on choice of valve head
-  Inlet / Outlet: Hose piece
-  Membrane: Depending on choice of valve head

## CERTIFICATION\*

· EU EC 1935/2004 · EU EC 2023/2006 · DK No 681 25/05/2020 · 3.1 Material Certificate · Ra Certificate · ATEX 2014/34/EU · PED 2014/68/EU · Keofitt DoC

## TECHNICAL DATA

### Material (process contact)

- Steel parts                      AISI 316L (1.4404)

### Material (without process contact)

- Steel parts                      AISI 316L (1.4404)
- Rubber cap                      EPDM (black)
- Stainless steel chain         AISI 316L (1.4404)

### Surface Treatment

- Outside                          Electropolished Ra ≤ 1.2 µm
- Inside (wetted surface)      Electropolished Ra ≤ 0.5 µm
- Process connection         Electropolished Ra ≤ 0.5 µm

### Pressure & Temperature

- Pressure                         Depending on choice of valve head
- Temperature                  Depending on choice of valve head
- Air supply                       Depending on choice of valve head

### Net Weight

- kg/lbs                            0.442 kg/0.974 lbs

### Spareparts

- 600062                            10 PACK RUBBER CAP W9/4KAI/BASIX
- 600064                            DOUBLE ST. ST. CHAIN

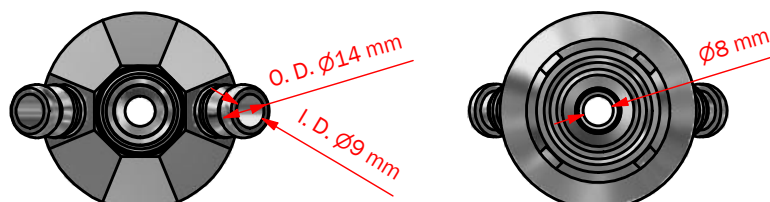
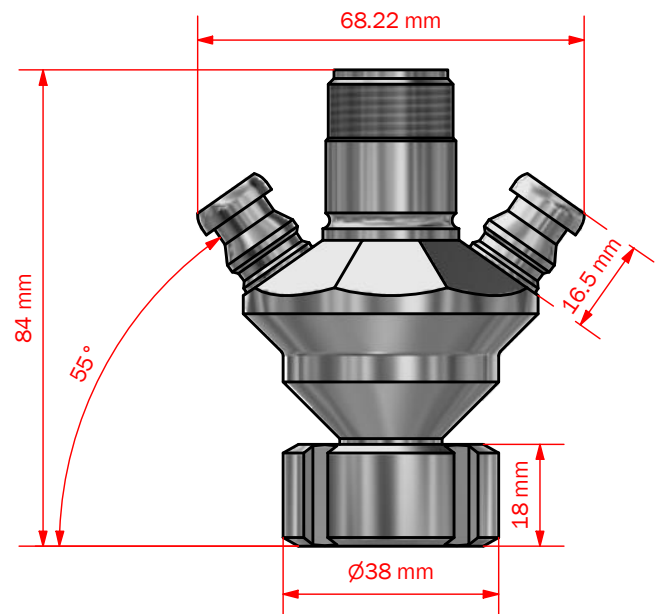

\*For further information and download please visit [www.keofitt.dk](http://www.keofitt.dk)