





VALVE HEAD W9 TYPE N/ADJUSTABLE PTFE



ART. NO. 855545

GENERAL

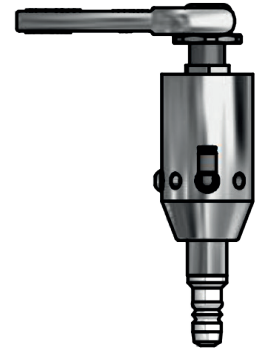
-  The KEOFIT CLASSIC W9 Sampling Valve is the original and leading sterilizable sampling valve in the world. Used in all industries for decades. More than 320 standard valve configurations. Unique serial no. for each valve*.
-  The sampling valve can be used for any process sampling for microbiological, chemical and/or physical analysis.
-  **Cleaning/sterilizing:** Between batches: Valve in open position: Cleanable by means of CIP using the detergent solution suitable for the actual process media. Between samples: Valve in its normal closed position: cleanable by CIP as “Between batches” or the valve may be sterilized by means of steam SIP or chemical SIP using a procedure appropriate to the actual circumstances. For further advice, please contact KEOFIT. Autoclavable.
-  Designed for sampling of liquids with a viscosity of up to approx. 1.000 cP containing no particles larger than Ø3 mm. Sampling of more viscous liquids is possible, only will it take longer (depending on process pressure).



FEATURES

-  Installation: Threaded socket connection M22x1.5
-  Membrane: PTFE (#850055)
-  Operation: Pneumatically operated / Lever handle (#600170)
Spring closed - when not pressurized.

CERTIFICATION*

- Valve head: EU EC 1935/2004 · EU EC 2023/2006 · EU EC 10/2011 · DK No 681 25/05/20 · ATEX 2014/34/EU · PED 2014/68/EU · FDA CFR 21 §177.2600 · USP Class VI · Keofitt DoC.
- Membrane: EU EC 1935/2004 · EU EC 2023/2006 · EU EC 10/2011 · DK No 681 25/05/20 · FDA CFR 21 §177.2600 · USP Class VI · ADI Free · Keofitt DoC.

TECHNICAL DATA

Material (process contact)

Membrane: PTFE, white (#850055)

Material (without process contact)

Steel parts: AISI 303 (1.4305) / AISI 316L (1.4404)
Lever handle: AISI 316L (1.4404)

Pressure & Temperature

Pressure: 0 - 10 bar / 0 - 145 psi
Temperature: 1 - 150°C / 34 - 302°F
Air supply: 4 - 7 bar / 58 - 101 psi

Net weight

Kg/lbs: 0.869 kg / 1.914 lbs

SPARE PARTS

778544 Parts for W9 head 855544/45

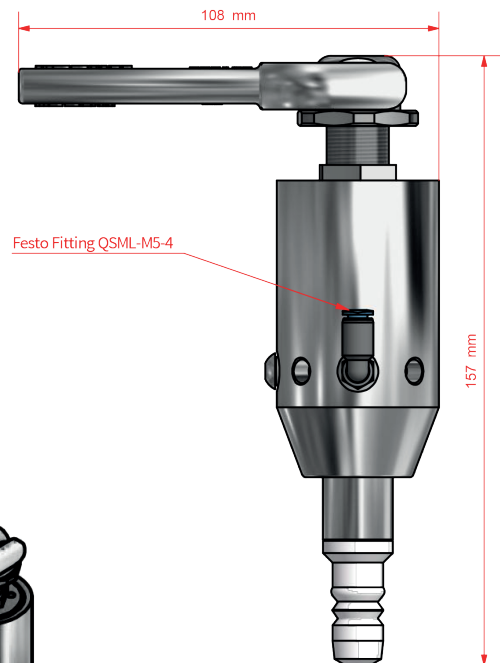

*For further information and downloads please visit www.keofitt.dk