





VALVE BODY W15 C1" 3/4" CLAMP



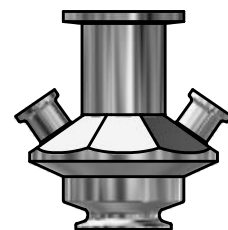

ART. NO. 860004

GENERAL

-  The KEOFITT CLASSIC W15 Sampling Valve is designed for high viscosity sampling such as fruit pulp etc.. Design based on the original KEOFITT and based on one-piece-construction. Unique serial no. for each valve*.
-  The sampling valve can be used for any process sampling for microbiological, chemical and/or physical analysis.
-  **Cleaning/sterilizing:** Between batches: Valve in open position: Cleanable by means of CIP using the detergent solution suitable for the actual process media. Between samples: Valve in its normal closed position: cleanable by CIP as "Between batches" or the valve may be sterilized by means of steam SIP or chemical SIP using a procedure appropriate to the actual circumstances. For further advice, please contact Keofitt.
-  Designed for sampling of liquids with a viscosity of up to approx. 50.000 cP containing no particles larger than Ø8 mm. Sampling of more viscous liquids is possible, only will it take longer (depending on process pressure).



FEATURES

-  Installation: 1" Clamp DIN 32676:2009-05 Table 4 Row C
-  Operation: Depending on choice of valve head
-  Inlet / Outlet: 3/4" Clamp DIN 32676:2009-05 Table 4 Row C
-  Membrane: Depending on choice of valve head

CERTIFICATION*

· EU EC 1935/2004 · EU EC 2023/2006 · DK No 681 25/05/20 · 3.1 Material Certificate · Ra Certificate · ATEX 2014/34/EU · PED 2014/68/EU · Keofitt DoC

TECHNICAL DATA

Material (process contact)

- Steel parts AISI 316L (1.4404)

Material (without process contact)

- Steel parts AISI 304 (1.4304)

Surface Treatment

- Outside Electropolished Ra ≤ 1.2 µm
- Inside (wetted surface) Electropolished Ra ≤ 0.5 µm
- Process connection Electropolished Ra ≤ 0.5 µm

Pressure & Temperature

- Pressure Depending on choice of valve head
- Temperature Depending on choice of valve head
- Air supply Depending on choice of valve head

Net Weight

- kg/lbs 1.831 kg/4.033 lbs

Spareparts

- NOT APPLICABLE

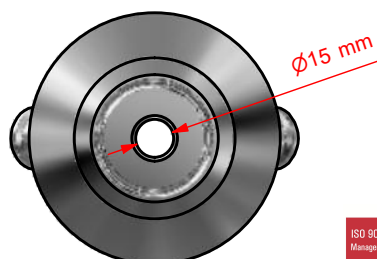
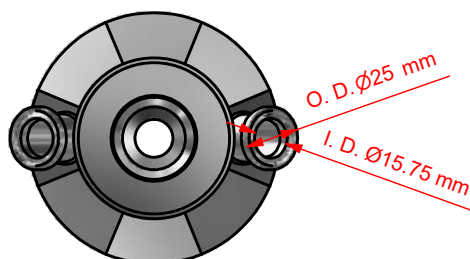
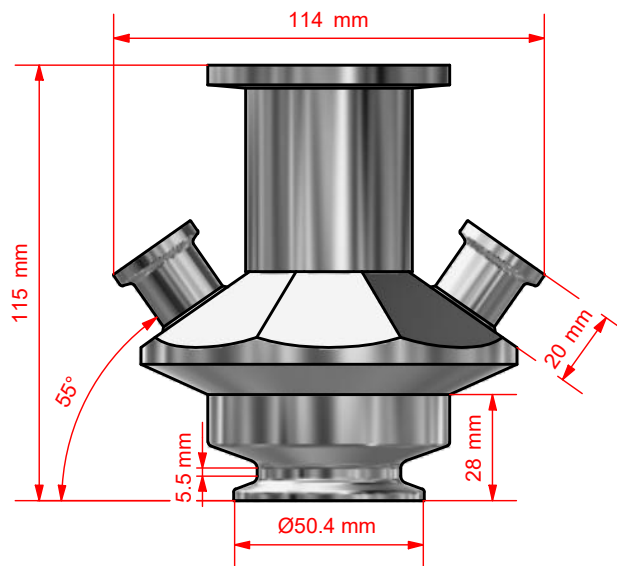

*For further information and download please visit www.keofitt.dk