





# VALVE BODY W15 VARIVENT Ø68 3/4" CLAMP



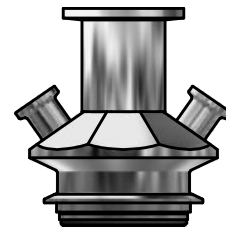

ART. NO. 860009

## GENERAL

-  The KEOFITT CLASSIC W15 Sampling Valve is designed for high viscosity sampling such as fruit pulp etc.. Design based on the original KEOFITT and based on one-piece-construction. Unique serial no. for each valve\*.
-  The sampling valve can be used for any process sampling for microbiological, chemical and/or physical analysis.
-  Cleaning/sterilizing: Between batches: Valve in open position: Cleanable by means of CIP using the detergent solution suitable for the actual process media. Between samples: Valve in its normal closed position: cleanable by CIP as "Between batches" or the valve may be sterilized by means of steam SIP or chemical SIP using a procedure appropriate to the actual circumstances. For further advice, please contact Keofitt.
-  Designed for sampling of liquids with a viscosity of up to approx. 50.000 cP containing no particles larger than Ø8 mm. Sampling of more viscous liquids is possible, only will it take longer (depending on process pressure).



## FEATURES

-  Installation: Varivent Ø68 connection
-  Operation: Depending on choice of valve head
-  Inlet / Outlet: 3/4" Clamp DIN 32676:2009-05 Table 4 Row C
-  Membrane: Depending on choice of valve head

## CERTIFICATION\*

· EU EC 1935/2004 · EU EC 2023/2006 · DK No 681 25/05/20 · 3.1 Material Certificate · Ra Certificate · ATEX 2014/34/EU · PED 2014/68/EU · Keofitt DoC

## TECHNICAL DATA

### Material (process contact)

- Steel parts                   AISI 316L (1.4404)
- O-ring                         EPDM, BLACK (#400208)
- EU EC 1935/2004 · EU EC 2023/2006 · DK No. 1248 10/2018
- FDA CFR 21 §177.2600 · USP Class VI · ADI Free · Keofitt DoC

### Material (without process contact)

- Steel parts                   AISI 304 (1.4304)

### Surface Treatment

- Outside                       Electropolished Ra ≤ 1.2 µm
- Inside (wetted surface)   Electropolished Ra ≤ 0.5 µm
- Process connection       Electropolished Ra ≤ 0.5 µm

### Pressure & Temperature

- Pressure                     Depending on choice of valve head
- Temperature               Depending on choice of valve head
- Air supply                   Depending on choice of valve head

### Net Weight

- kg/lbs                        2.186 kg/4.816 lbs

### Spareparts

- NOT APPLICABLE

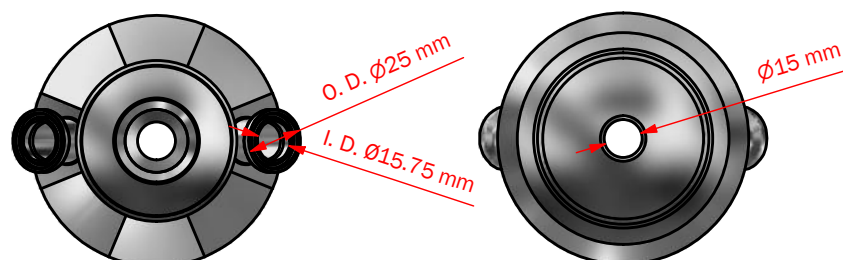
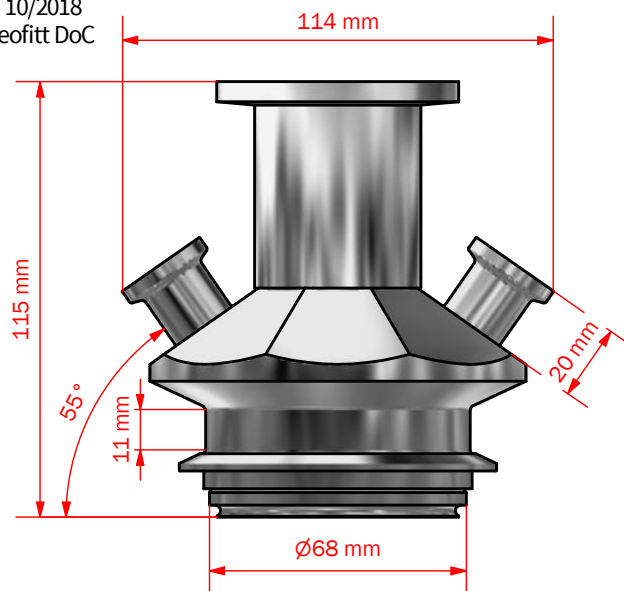

\*For further information and download please visit [www.keofitt.dk](http://www.keofitt.dk)