





SESAME VALVE HEAD TYPE Q



ART. NO. 895543

GENERAL

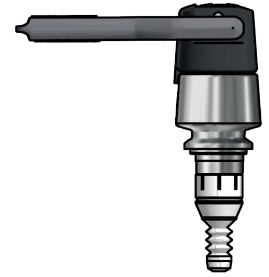
-  The KEOFITT SESAME Sampling Valve is our patented dual-seat sampling valve. Unique in the market, it eliminates dead-leg during sampling while incorporating steam supply control. Unique serial no. for each valve*.
-  The sampling valve can be used for any process sampling for microbiological, chemical and/or physical analysis.
-  **Cleaning/sterilizing:** Between batches: Valve in open position: Cleanable by means of CIP using the detergent solution suitable for the actual process media. Between samples: Valve in its normal closed position: cleanable by CIP as “Between batches” or the valve may be sterilized by means of steam SIP or chemical SIP using a procedure appropriate to the actual circumstances. For further advice, please contact KEOFITT. Not recommended for autoclave due to plastic parts.
-  Designed for sampling of liquids with a viscosity of up to approx. 1.000 cP containing no particles larger than Ø3 mm. Sampling of more viscous liquids is possible, only will it take longer (depending on process pressure).



FEATURES

-  Installation: Clamp connection (clamp ring included #900189)
-  Membrane: PTFE (#890055)
-  Operation: Lever handle (#890170)

CERTIFICATION*

- Valve head: EU EC 1935/2004 · EU EC 2023/2006 · EU EC 10/2011 · DK No 681 25/05/20 · ATEX 2014/34/EU · PED 2014/68/EU · FDA CFR 21 §177.1550 · USP Class VI · KEOFITT DoC.
- Membrane: EU EC 1935/2004 · EU EC 2023/2006 · EU EC 10/2011 · DK No 681 25/05/20 · FDA CFR 21 §177.1550 · USP Class VI · ADI Free · KEOFITT DoC
- O-ring: EU EC 1935/2004 · EU EC 2023/2006 · DK No 681 25/05/20 · FDA CFR 21 §177.2600 · USP Class VI · REACH · RoHS · ADI Free · KEOFITT DoC

TECHNICAL DATA

Material (process contact)

Membrane: PTFE, white (#890055)

Material (without process contact)

- Steel parts: AISI 316L (1.4404)
- Knob: PA6-3G-1L2 (black)
- Lever handle: AISI 316L (1.4404)
- O-ring: EPDM, black (#880830)

Pressure & Temperature

- Pressure: 0 - 10 bar / 0 - 145 psi (process & CIP/SIP)
- Temperature: 1 - 150°C / 34 - 302°F
- Air supply: -

Net weight

Kg/lbs: 0.835 kg / 1.84 lbs

SPARE PARTS

#890055 Membrane PTFE Sesame w/EPDM O-ring

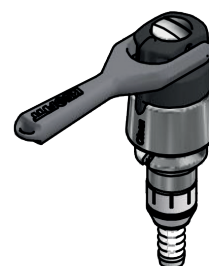
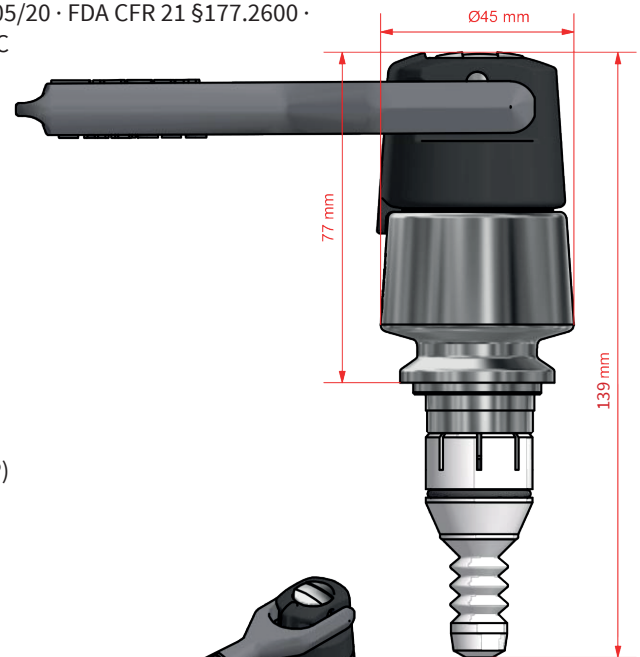

*For further information and downloads please visit www.keofitt.dk