





MICRO PORT TYPE T





ART. NO. 900056

GENERAL

-  The KEOFITT MICRO PORT is a re-sealing rubber septum designed to take samples using hypodermic needles or syringes with minimal risk of cross-contamination. Designed for sampling low viscosity products. Unique serial no. for each Micro Port*.
-  The MICRO PORT can be used for any process sampling for microbiological, chemical and/or physical analysis.
-  Designed for sampling of liquids with a viscosity of up to approx. 50 cP containing no particles larger than Ø0.8 mm.
-  Please note that the sealing capacity is reduced with piercing.



FEATURES

-  Installation: Tank welding
-  Operation: Manually operated
-  Recommended to be used with hypodermic needle (#900054).
-  Septum: Butyl IIR (#900049)

CERTIFICATION*

· EU EC 1935/2004 · EU EC 2023/2006 · DK No 681 25/05/20 · 3.1 Material Certificate · Ra Certificate · PED 2014/68/EU · FDA CFR 21 §177.2600 · USP Class VI · ADI Free · Keofitt DoC

TECHNICAL DATA

Material (process contact)

- Steel parts AISI 316L (1.4404)
- Septum Butyl IIR (LIGHT GREY/WHITE, #900049)

Material (without process contact)

- Steel parts AISI 316L (1.4404)
- O-ring EPDM, BLACK (#900825)
- Stainless steel chain AISI 316L (1.4404)

Septum

- Article Butyl IIR (LIGHT GREY/WHITE, #900049)
- Certification* · EU EC 1935/2004 · EU EC 2023/2006 · DK No 681 25/05/20 · FDA CFR 21 §177.2600 · USP Class VI · ADI Free · Keofitt DoC

Surface Treatment

- Outside Electropolished Ra ≤ 1.2 µm
- Inside (wetted surface) Electropolished Ra ≤ 0.5 µm
- Process connection Electropolished Ra ≤ 0.5 µm

Pressure & Temperature

- Pressure 0 - 10 bar / 0 - 145 psi
- Temperature 1 - 110°C / 34 - 230° F
- Air supply -

Net Weight

- kg/lbs 0.161 kg/0.354 lbs

Spareparts

- 779056 PARTS MICROPORT 900014/56/57/58/59

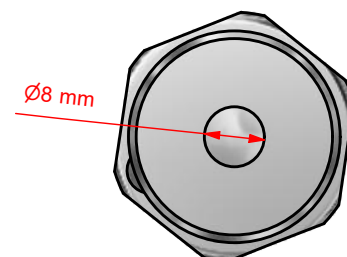
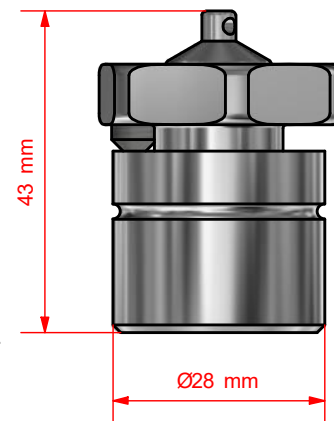

*For further information and download please visit www.keofitt.dk